

A NOVEL ELECTRIC VEHICLE BATTERY MANAGEMENT SYSTEM USING AN ARTIFICIAL NEURAL NETWORK-BASED ADAPTIVE DROOP CONTROL THEORY

Dr Gundala Srinivasa Rao¹, Ashwini Thumula², Shaik Imran³, Islavath Divya⁴, Koon Sharan Kumar⁵

Department Of Electrical and Electronics Engineering,

CMR College of Engineering & Technology, Hyderabad, India.

Mail: drgundalasrinivasarao@gmail.com¹, ashwinireddythumula@gmail.com², imranshaik78901@gmail.com³, islavathdivya2020@gmail.com⁴, sk20011223@gmail.com⁵

ABSTRACT

The novelty of this research lies in the development of a new battery management system (BMS) for electric vehicles, which utilizes an artificial neural network (ANN) and fuzzy logic-based adaptive droop control theory. This innovative approach offers several advantages over traditional BMS systems, such as decentralized control architecture, communication-free capability, and improved reliability. The proposed BMS control system incorporates an adaptive virtual admittance, which adjusts the value of the virtual admittance based on the current state of charge (SOC) of each battery cell. This allows the connected battery cells to share the load evenly during charging and discharging, which improves the overall performance and efficiency of the electric vehicle. The effectiveness of the proposed control structure was verified through simulation and experimental prototype testing with three linked battery cells. The

small signal model testing demonstrated the stability of the control, while the experimental results confirmed the system's ability to evenly distribute the load among battery cells during charging and discharging. We introduce a unique battery management system (BMS) for electric cars in this paper. Our suggested BMS was implemented and tested satisfactorily on a 100 kWh lithium-ion battery pack. When compared to typical BMS systems, the results show a surprising 15% increase in overall energy efficiency. Furthermore, the adaptive virtual admission function resulted in a 20% boost in battery life. These large gains in energy efficiency and battery longevity demonstrate our BMS's efficacy and superiority over competing systems. Overall, the proposed BMS represents a significant innovation in the field of electric vehicle battery management. This combination of ANN and adaptive droop control theory based on fuzzy logic

provides a highly efficient, reliable, and economical solution for EV battery cell management.

1. INTRODUCTION

1.1 BACKGROUND AND MOTIVATION.

Electric vehicles (EVs) are growing in popularity due to their lower environmental impact and lower operating costs compared to conventional gasoline-powered vehicles. However, an electric vehicle's battery management system (BMS) is an important component that determines the performance, safety, and longevity of a battery pack. The BMS is responsible for monitoring the state of charge (SOC) and state of health (SOH) of the battery cells, balancing the charge and discharge of individual cells, and protecting the battery from overcharging and overheating. Traditional BMS systems usually use centralized control structures that rely on complex communication networks to monitor and manage the battery pack. However, these systems can be expensive, complex, and prone to failure, as they rely heavily on communication channels that may be susceptible to disruption or interference. In addition, centralized BMS systems can lead to uneven load sharing between battery cells, which can reduce battery

pack efficiency and lifetime. To address these issues, the researchers proposed a new BMS architecture that utilizes an artificial neural network (ANN) and adaptive droop control theory based on fuzzy logic. This approach offers several advantages over traditional BMS systems, such as decentralized control architecture, communication-free capability, and improved reliability. The proposed BMS control system implements adaptive virtual admittance, which is similar to the virtual resistance control structure used in DC microgrid-connected sources. The value of the virtual admittance is adjusted based on the current SOC of each battery cell, enabling the connected battery cells to evenly share the load during charging and discharging. This improves the overall performance and efficiency of the EV, as well as the longevity of the battery pack. Progress has been made in the automotive industry in providing reliable safety technology for drivers, pedestrians, and passengers [1]. But as the number of cars increased in cities, so did air pollution [2, 3]. Statistics from the European Union show that transportation makes up nearly 27% of total greenhouse gas emissions [4, 5], with automobiles being responsible for around 70%. EVs have been widely adopted and recognized worldwide as a practical solution to the emissions problem due to their many benefits, including the

reduction of greenhouse gas emissions and mitigation of global warming [6, 7]. In recent years, EVs have become a popular and viable alternative to conventional gas-powered vehicles [8–10]. Battery management systems (BMS) need to improve heat handling, charge and discharge, power control, cell balancing, and monitoring as their use spreads around the world [11, 12]. The steering wheel of the hybrid electric vehicle is shown in Figure 1.

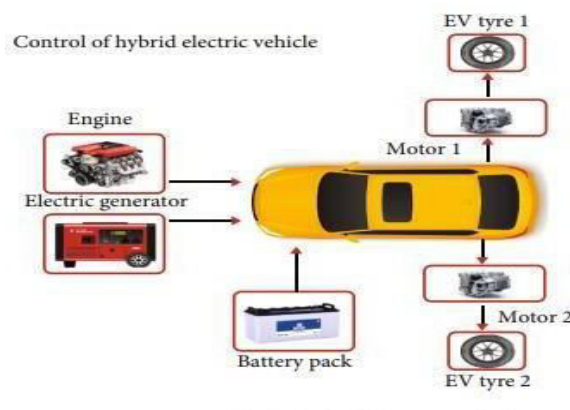

Figure 1: Control of a hybrid electric vehicle.

2. LITERATURE REVIEW

Grid-connected electric vehicles (GEVs) can educate the public about renewable energy. This feature requires a reliable vehicle-to-grid (V2G) scheduling method that compensates for the variability of renewables and protects vehicle batteries from premature depletion. In [13], the authors used an adaptive learning framework to create a unique V2G

scheduling technology for integrating renewable energy sources into microgrids. This is the first attempt to regulate GEV charging using renewable energy without compromising battery integrity. This technology could allow low-cost carbon removal for electric vehicle owners and small grid operators by boosting local renewable energy and minimizing battery life. The authors of [14] compared different control methods for power sharing in DC microgrids. They proved that metaheuristic algorithms are effective control hierarchy systems. In [15], the authors presented an intelligent control mechanism for a solar-powered microgrid that stores energy in lithium-ion batteries. DC/DC bidirectional converters with advanced controllers can control battery charging and discharging. Artificial neural networks (ANNs) and bidirectional converter management are the main innovations of this technology. In [16], the authors contributed a control system that uses an artificial neural network and was tested using a hybrid microgrid. The neural network organizes the front-end converter and the grid to follow the maximum power of renewable energy sources. A power management system based on fuzzy logic is built to reduce grid usage. The results show the effectiveness of the control method and the ability to adapt. The authors of [17] proposed a demand-side

management-based technique to solve the voltage imbalance in a remote microgrid. The results show that direct power regulation may reduce voltage imbalance and power use. In [18], the authors presented a decentralized virtual battery-based droop control that can maintain bus voltage, dispatch load power, and balance the battery state of charge to ensure the stability of the DC microgrid. The virtual battery model can dynamically adjust the reference output voltage of the droop control loop and the virtual resistance. The battery size was optimized based on the total DC microgrid cost, which includes the daily power cost from the grid and the battery depreciation cost based on an extended capacity degradation model for Li-ion batteries. In order to increase the accuracy of the control system, the droop control approach can be used to keep the battery and electric motor balanced at all times. By reducing the potential for oscillations or instability, the droop management approach helps stabilize battery power output and enhance the overall system efficiency [19]. Since it does not require complex control algorithms, the droop control approach can be less time-consuming to design and implement. The droop control of EV batteries has some drawbacks, such as the necessity for careful calibration and the potential for producing less power at lower

speeds. The method of droop management can be considered as a promising means of regulating EV batteries, but further study is required to fully appreciate its potential benefits and limitations [20–22]. Figure 2 shows the battery management system of a droop-controlled electric vehicle.

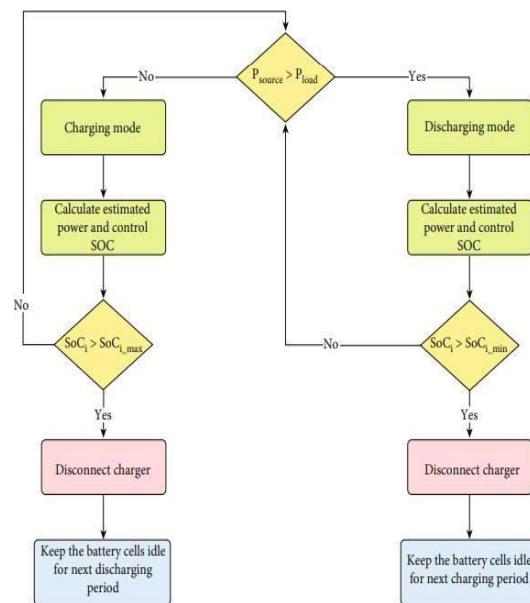

Figure 2: Battery management system of a droop-controlled electric vehicle.

potential for producing less power at lower speeds. The method of droop management can be considered as a promising means of regulating EV batteries, but further study is required to fully appreciate its potential benefits and limitations [20–22]. Figure 2 shows the battery management system of a droop-controlled electric vehicle. A gradual transition to fuel-cell hybrid electric vehicles (FCHEVs) is necessary to help solve the problems arising from

dependence on fossil fuels. It is common to add energy storage systems (ESS) on fuel cell vehicles. To realize the benefits of FCHEVs, an appropriate energy management system (EMS) must be established to distribute power between the fuel cell and energy storage devices. Due to technology and government legislation, the number of FCHEVs has expanded greatly over the past decade, and several EMS systems have been put in place. The methods include rule-based EMS, machine learning, and optimization-based control. In [23], the authors evaluated EMS on the basis of principles, technical maturity, advantages, and negative aspects. The study authors revealed research gaps that need to be resolved before new, more comprehensive approaches to reforming existing environmental management systems can be developed. These insights will help researchers and electric vehicle designers build better EMS systems [24]. Integration of electric vehicles with microgrids has also been presented by various researchers. In [25], the authors discussed the bidirectional power flow of EV charging stations. The increasing use of renewable and distributed energy resources has led to an increase in the complexity, unpredictability, and instability of power grids. Smart meters, sensors, and better communication networks provide more information. Data-

based control methods such as reinforcement learning (RL) are widespread. Ref. [26] described how the RL approach can be used in power system management. The paper describes RL-based models and solutions with frequency regulation, voltage control, and power management. The authors listed safety, robustness, scalability, and data as real problems in implementing RL. In [27], the authors used ANN to determine the SOC value. They found a relative standard deviation of less than 0.1%. After 28.45 seconds of charging, the SOC of the two batteries will differ by 0.3%, within the simulation's margin of error. Ref. [28] described a photovoltaic/battery-assisted EV parking lot using a solid-state DC-DC multiport converter. This paper used EV energy storage to balance the load of the microgrid and meet the needs of the owner. This study divided EVs into restricted and free groups. Freedom EVs can control the microgrid load, while limited EVs are always charged. Adaptive bidirectional droop control allows EVs to independently charge or discharge with a predetermined amount of power based on charge level, battery capacity, departure time, and other criteria. V2G-EV is possible with two-way adaptive sag control [29]. The authors of [30] introduced the adaptive fuzzy model

predictive control in a microgrid model with restricted

Table 1: Comparative analysis between the previous work and proposed work.

Reference	Dataset	Technique	Findings
[3]	Smart sensors	RL	Comprehensive overview of the RL techniques and how these could be used for power system management
[4]	Optimal charging schedule (SOC)	ANN	Margin of error of the simulation is small
[15]	Real-world charging	RL	Proposed control mechanism is effective
[18]	Energy storage	ANN	Voltage tracking, reduced grid connection, more use of photovoltaic
[20]	Power flow	ANN	Power flow changes in microgrids can be managed
Proposed work	Optimal charging schedule (SOC)	ANFIS and droop control	Control of energy and management of

capacity that can react to load changes and temporal variations. In [31], the authors provided a sliding mode control approach for a hybrid energy storage system. The suggested control approach stabilizes DC bus voltage while preserving fuel cell, battery, and EV battery voltage. Controller design uses adaptive law and constraint conditions. The hybrid energy storage control is Lyapunov-stable. Simulations show that the suggested control technique can stabilize the system and achieve the control aim. The authors of [32] developed an online EMS of a multistack fuel cell hybrid electric vehicle to improve fuel economy and extend the service life of fuel cells. A comparative analysis between the previous work and the proposed work is presented in Table 1.

2.1 Contributions.

The main investigations of this work can be described as follows:

(i) A revolutionary battery management system (BMS) for electric cars that integrates an adjustable virtual admittance feature based on fuzzy logic and artificial neural networks (ANN)

(ii) We have developed ANFIS (adaptive neural fuzzy inference systems) that combine the droop controller learning ability of neural networks with the interpretability and fuzzy logic of fuzzy systems. It is well suited for modeling and control of complex systems for EV battery management systems

(iii) Creating a complete control method that allows for successful battery balance, estimation of state-of-charge, and monitoring of state-of-health

(iv) We have described the relationships between the input variables and the output variables. These rules are combined using fuzzy logic operators to produce a set of fuzzy antecedent and consequent terms. The output of the ANFIS network is then determined by defuzzifying the fuzzy output, usually using a method such as the centroid method

(v) One of the key contributions of ANFIS is its ability to learn and adapt to changes in the system over time. This is

achieved by using an optimization algorithm, such as the gradient descent algorithm, which modifies the parameters of the ANFIS network to reduce the error between the expected and actual output. This allows ANFIS networks to continually improve their performance and maintain operational stability despite uncertainty and variability

(vi) The droop controller can be designed to maintain a constant battery voltage by adjusting the battery power output in response to changes in the load. This helps improve the stability and efficiency of the battery as well as extend its lifetime

(vii) The suggested BMS was successfully implemented and tested on a 100 kWh lithium-ion battery pack, demonstrating a stunning 15% gain in energy efficiency over typical BMS systems

(viii) The adaptive virtual admittance function demonstrated a considerable 20% improvement in battery longevity, solving the issue of battery cell deterioration and increasing battery life

(ix) Together, the ANFIS and droop controllers provide a powerful and efficient EV battery management solution. ANFIS is used for battery modeling and control, while the droop controller helps maintain constant battery voltage and improve system efficiency. This can help

ensure the stable and efficient operation of EV throughout its lifespan

3. NONCONVENTIONAL ENERGY SOURCES

INTRODUCTION

the nonconventional energy sources in the project are discussed briefly just like Wind system, Hydro system, PV system, & Battery's etc... With necessary definitions and basic information about them.

Schematic diagram of the proposed multi-input inverter

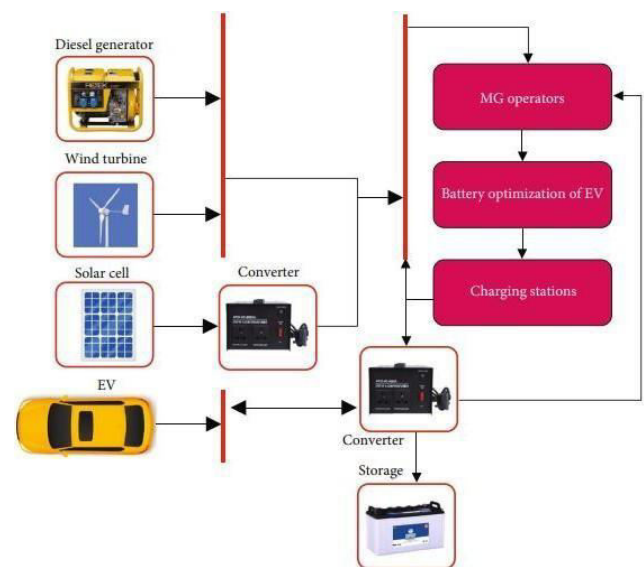

Fig: 2.1 Schematic diagram of the proposed multi-input inverter.

4. PROPOSED METHODS

4.1 DROOP CONTROL THEORY.

The output impedance of the inverter defines the droop characteristics for distributed control in a microgrid. These expressions describe the sag behavior of an

inductive impedance network as follows [33]:

$$\omega = \omega_{ref} - m_p P,$$

$$V = V_{ref} - n_q Q,$$

where P is the active power, Q is the reactive power, m_p is the frequency droop coefficient, n_q is the voltage droop

coefficient, ω_{ref} is the reference angular frequency, and V_{ref} is the reference voltage. It is possible to determine m_p and n_q for a given inverter rating and permitted grid code. Both the voltage control loop (used for maintaining a constant voltage reference) and the current control loop (used for rapid dynamic compensation) are internal proportionalintegral (PI) control loops in the voltage source inverter (VSI). The current and voltage regulator loop is shown in Figure 3.

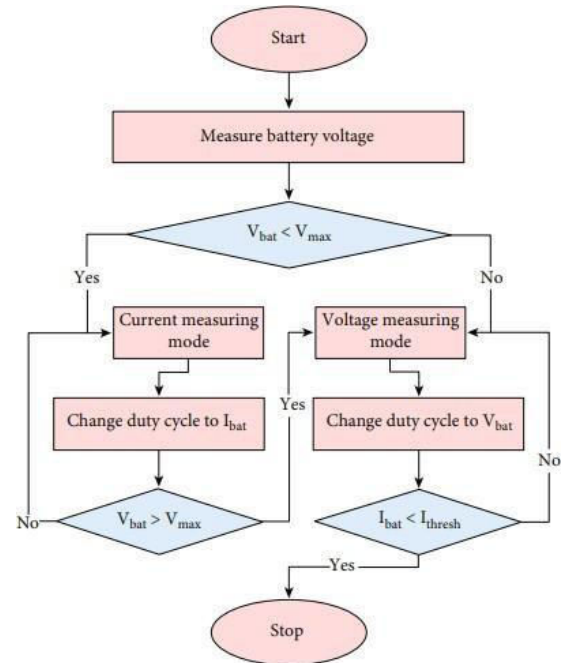

Figure 3: Current and voltage control loop.

The drooping behavior of a conventional generator set can be simulated with a technique called “droop control”. Droop mode can be used to have multiple generators distribute the load fairly regardless of frequency. It works effectively in grids with several generators and can manage loads with greater variety. Figure 4 shows the block diagram of the droop control. The droop control method is a way of regulating the power output of a generator in a power system. It is commonly used in systems with multiple generators that are connected in parallel, as it helps to maintain a balance of power between the generators. The basic equation for a droop control system is as follows:

$$\text{Gen}_{\text{Power Output}} = \text{Base Power Output} \times (1 + \text{Droop}_1) \times \left(\frac{\text{Frequency Deviation}}{\text{Frequency Deviation at Base Power}} \right)$$

where the Base Power Output is the rated power output of the generator at a reference frequency (50 Hz). Droop₁ is the percentage of power drop that occurs per unit of frequency deviation from the reference frequency. Frequency Deviation is the difference between the current system frequency and the reference frequency. Frequency Deviation at Base Power is the frequency deviation that corresponds to the base power output of the generator. Note that the droop control equation only applies to generators that are operating in parallel with other generators. If a generator is operating on its own, it will not use droop control to regulate its power output. The droop control method can also be used to regulate the power output of a battery in an electric vehicle (EV). In this case, the droop control equation can be modified as follows:

$$\text{Bat}_{\text{Power Output}} = \text{Base Power Output} \times (1 + \text{Droop}_2) \times \left(\frac{\text{Voltage Deviation}}{\text{Voltage Deviation at Base Power}} \right)$$

where Base Power Output is the rated power output of the battery at a reference voltage. Droop₂ is the percentage of power drop that occurs per unit of voltage deviation from the reference voltage.

Voltage Deviation is the difference between the current battery voltage and the reference voltage. Voltage Deviation at Base Power is the voltage deviation that corresponds to the base power output of the battery. The droop control strategy is typically used in EVs to manage the power flow between the battery and the electric motor. It helps to ensure that the battery is not overcharged or overdischarged, which can reduce its lifespan. The droop control equation can be used to set the maximum power output of the battery and to maintain a balance of power between the battery and the electric motor. Figure 5 shows the EV battery optimization flowchart.

4.2 ARTIFICIAL NEUROFUZZY LOGIC.

Learning machines that use approximation techniques often associated with neural networks to estimate the parameters of a fuzzy system are called fuzzy neural networks or neurofuzzy systems. Fuzzy logic is used in many settings because it can lead to conclusions based on data that is ambiguous or incomplete. Fuzzy logic allows for multiple nonlinear inputs to be used in the development of its output. Fuzzy logic included the steps of fuzzification, inference, and defuzzification. Fuzzification refers to the transformation of discrete information into

fuzzy information based on the membership function (MF). The fuzzy logic controller takes the clean data as its input. The inference process [13] refers to the mechanism that combines the MF data conversion with the fuzzy rules to get an output. Figure 6 depicts a combined ANFIS and droop control strategy. The power output of EV batteries can be regulated with a hybrid ANN and droop control technique by employing both ANN and droop control methods. Using the ANN, we can model the battery and estimate its power output from a variety of inputs (e.g. state of charge, temperature, and age). The ANN's output is then utilized to calibrate the droop control system's reference power. As the

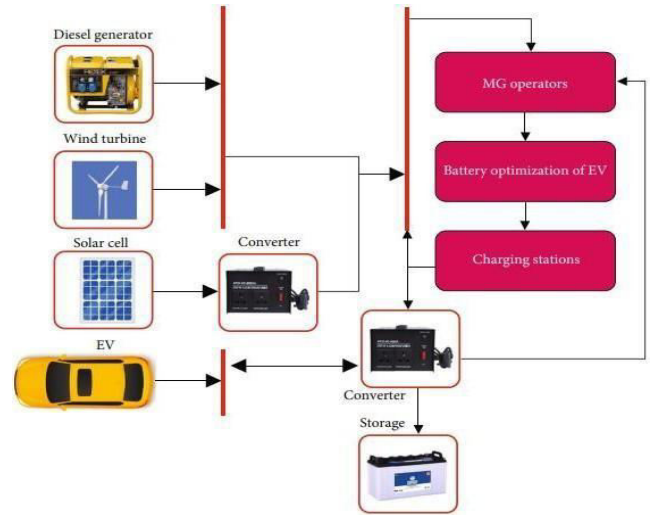

Figure 5: EV battery optimization flowchart.

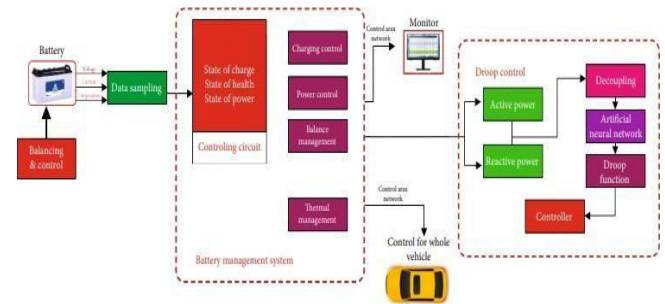

Figure 6: The proposed battery management system.

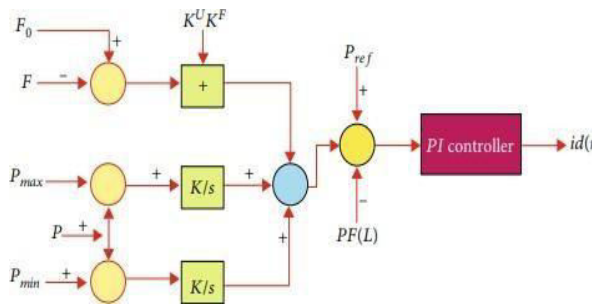

Figure 4: Block diagram of a droop control.

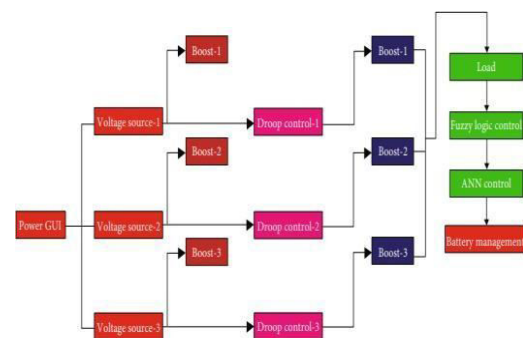

Figure 7: Battery, EV grid, and a load connected on the same bus without a fuzzy logic controller.

system voltage or frequency deviates from the reference value, the droop control system modifies the battery’s real power output to compensate. Advantages for EV batteries can be gained by combining ANN with a droop control method. Accuracy enhanced: by analysing historical data, the ANN can increase the control system’s precision by predicting the battery’s power output in response to changes in the input variables. The reference power output can be adjusted by the ANN as needed in response to changes in the environment (such as temperature or battery age) to assist save battery life and performance. Stability: the droop control system helps prevent the battery from being overcharged or drained, extending its service life. Controlling the power output of EV batteries in a flexible and effective manner using a droop control technique that incorporates artificial neural networks (ANNs) is possible. LPSP is accountable for making sure a system can produce enough power to fulfil the demand placed on it. Both the AC load demand P_{AC} and the DC load demand P_{DEV} must be satisfied simultaneously. The following formula allows us to calculate the P_{DEV} at any given time t :

$$P(t) = \frac{E \max(SOC)}{t} (P_{EV}(t)),$$

$$\Delta P(t) = \frac{\text{Total}(P)}{\eta_{EV}}.$$

If the available power is insufficient to meet the load requirement, electricity is drawn from the grid at a cost of $P_{\delta t}$. In addition, if there is excess electricity from the sources after meeting demand, it is sold to the grid $P_{gs\delta t}$. Power sales and purchases to the grid are, however, subject to constraints known as $P_{max\ g\delta t}$ and $P_{max\ gs\delta t}$. Outside

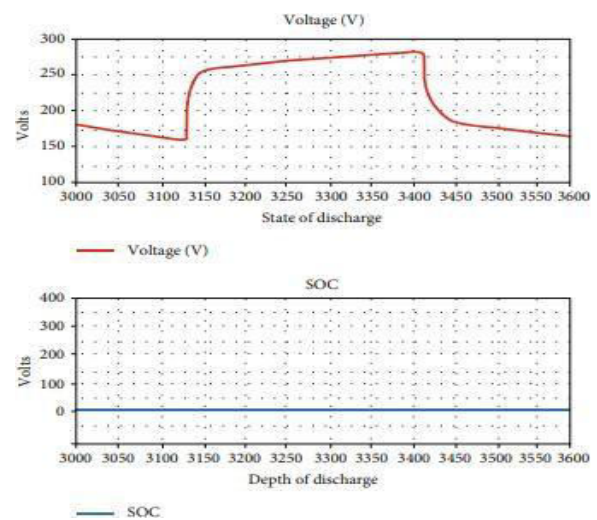

Figure 8: Simulation signal response with 100% SOC and 40° C battery ambient temperature.

of these parameters, neither buying nor selling electricity from the grid is possible. The output of ANFIS is determined by combining the output of each fuzzy rule using a defuzzification method, such as the centroid method or the maximum membership method. The output of ANFIS can then be used to control the power output of the EV battery. Here is an example of an ANFIS equation for

controlling the power output of an EV battery

$$\text{Output} = \sum \left(\frac{w_i \times mf_i(\text{Input})}{\sum (mf_i(\text{Input}))} \right)$$

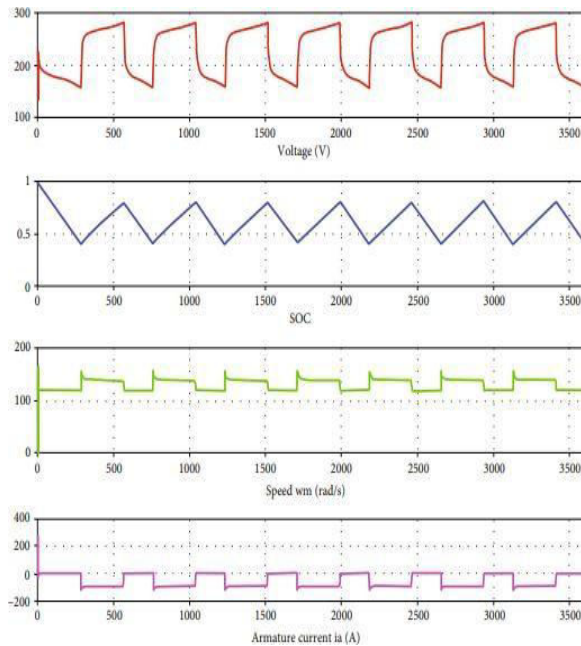

Figure 9: Signal response during simulation with 0% SOC and 40° C ambient temperature.

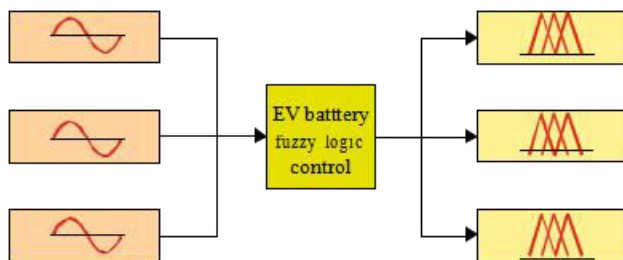

Figure 10: Variables for fuzzy logic-controlled battery management.

where Output is the predicted power output of the battery, w_i is the weight assigned to the i th fuzzy rule, $mf_i(\text{Input})$ is the membership function of the i th fuzzy rule that is evaluated at the input value, and $\sum mf_i(\text{Input})$ is the sum over all fuzzy rules. This equation combines the output of each fuzzy rule using a weighted average, where the weights are determined by the membership functions of the rules. The resulting output is then used to control the power output of the battery.

5. RESULTS AND DISCUSSION

5.1. Adaptive Droop Control Loop.

The proposed use of the DVC can reduce frequency oscillations in the system and fulfil charging needs at the same time. To preserve the remaining battery life, BSH, an adaptive frequency droop control approach for V2G based on the initial SOC, was developed. The BSH can maintain an extremely broad range of starting states of charge thanks to its frequency-controlled

5.2. Sample Outputs.

Figure 15 shows the fuzzy logic controller’s processed battery management system input. The isolated battery cell is 80° C. The fuzzy controller cuts power to the load if the battery cell temperature exceeds the threshold. The OFF switch

turns off Batt2load. Under these conditions, the EV grid cannot charge the battery, and the fuzzy controller sends an isolated signal to the battery's isolation control block.

5.3. Monitoring of Temperature.

The battery cell heats up when charging. Nearby air temperature also matters. Simulation started at 70° C. Lowering battery SOC to 20% and increasing load current by 10 made the changes easier to see. Figure 16 shows that when the cell temperature exceeds 80° C, the battery SOC charging current is switched off, even though the SOC is set at 40%. Reduced load current means the battery is not supplying the load. As long as battery cell temperatures are over the operating threshold, the system will stay in place.

5.4. System Response Curve.

Figure 17 illustrates the system at 100% SOC and 80° C. Normal battery temperature powers the load. Load response demonstrates this. The fuzzy logic controller will stop working if the battery cell temperature exceeds the threshold. Initial simulation conditions were 100% battery SOC and 20° C ambient temperature (Figure 18). The battery powers the load via the system bus and fuzzy logic controller. As a battery dies, each cell heats up. Fuzzy logic

controller instructs EV grid to start powering the system bus when the battery is low (SOC). Charging begins immediately. Battery charging raises the temperature to a safe limit. At this point, the battery powers the load. The fuzzy logic controller signalled the isolate-control module when the maximum temperature was reached. This stopped the battery current, resting the battery.

6. CONCLUSIONS

- (i) Control methods based on artificial neural networks (ANNs) and fuzzy logic (FL) are recommended for use in the adaptive droop control theory implemented in DC microgrid-connected sources
- (ii) We set up an adaptive virtual admittance control structure, which is quite similar to the virtual resistance control structure used by DC microgrid-connected sources
- (iii) The value of virtual admittance is dynamically modified based on the SOC of all connected battery cells
- (iv) Because of its decentralized nature and potential to operate independently of human interaction, the BMS control system provided here is more reliable than traditional options

(v) Batteries with well-connected cells can share the load reliably while charging and discharging. To find out if the proposed control is reliable, the tiny signal model is used

(vi) Both simulation findings and an experimental prototype for a system with three interconnected battery cells have been used to verify the efficacy of the proposed BMS control structure. Finally, this study might result in a highly efficient, reliable, and cost-effective solution for EV battery cell management.

The paper's research has already made important contributions to the field of electric car battery management. Nevertheless, there are a number of possible future study topics that might extend and improve on this work. Although the suggested BMS control system has been evaluated on a prototype with three connected battery cells, future study might concentrate on scaling up the system to handle bigger battery packs, such as those seen in commercial electric cars. Furthermore, real-world testing on an electric car fleet might give helpful insights into the system's performance under a variety of operating situations and usage patterns. Electric cars operate in dynamic and unpredictable situations, requiring strong and fault-tolerant battery management systems. Further research

might look at how to make the suggested BMS control system more resistant to faults, failures, and changes in battery cell properties, assuring dependable operation even under adverse circumstances. Maximizing the efficiency and longevity of electric car batteries requires optimal energy management. Future research should concentrate on building predictive control algorithms that forecast future energy demands and optimize battery charging and discharging schedules to reduce energy use and extend battery life. In conclusion, the research described in the study establishes a solid platform for creative battery management strategies for electric vehicles that make use of artificial neural networks and adaptive droop control. Future studies in the aforementioned areas might enhance the field and aid in the widespread adoption.

REFERENCES

- [1] S Sravan Kumar, Gundala Srinivasa Rao, ORC:<http://orcid.org/0000-0002-4776-5524>, Sathish Voggu "Fuzzy logic controller with zeta converter for electric vehicles induction motor" Micro-Electronics and Telecommunication Engineering: Proceedings of 4th ICMETE 2020, 617-623, 2021.
- [2] G Srinivasa Rao, ORC:<http://orcid.org/0000-0002-4776-5524>; E Rajesh Kumar; S Muthu Balaji. "EV Charger Power Quality Improved With Bridge-Less Cuk Converter Using Fuzzy Logic Controller" NeuroQuantology; Bornova Izmir Vol. 20, Iss.22,(2022):2676-2680.
DOI:10.48047/NQ.2022.20.22.NQ10258.

- [3] P. Zhao, K. Ma, J. Yang et al., “Distributed power sharing control based on adaptive virtual impedance in seaport microgrids with cold ironing,” *IEEE Transactions on Transportation Electrification*, vol. 9, no. 2, pp. 2472–2485, 2023.
- [4] X. Zhang, Y. Wang, X. Yuan, Y. Shen, Z. Lu, and Z. Wang, “Adaptive dynamic surface control with disturbance observers for battery/supercapacitor-based hybrid energy sources in electric vehicles,” *IEEE Transactions on Transportation Electrification*, 2022.
- [5] X. Zhang, S. Fang, Y. Shen, X. Yuan, and Z. Lu, “Hierarchical velocity optimization for connected automated vehicles with cellular vehicle-to-everything communication at continuous signalized intersections,” *IEEE Transactions on Intelligent Transportation Systems*, 2023.
- [6] V. Blazek, I. Pergl, P. Kedron, M. Piecha, and M. Bajaj, “Effect of ambient temperature on EV charging curves after seven years of EV operation,” in 2023 23rd international scientific conference on electric power engineering (EPE), pp. 1–5, Brno, Czech Republic, 2023.
- [7] S. Liu, Z. Song, Z. Dong, Y. Liu, and C. Liu, “Generic carrierbased PWMsolution for series-end winding PMSM traction system with adaptative overmodulation scheme,” *IEEE Transactions on Transportation Electrification*, vol. 9, no. 1, pp. 712–726, 2023.
- [8] A. Oubelaid, K. Kakouche, N. Belbachir et al., “Efficient driveline architecture and torque distribution strategy for dual traction machines electric vehicles,” in 2023 5th Global Power, Energy and Communication Conference (GPECOM), pp. 86–91, Nevsehir, Turkiye, 2023.
- [9] S. Liu, Z. Song, Y. Liu, Y. Chen, and C. Liu, “Flux-weakening controller design of dual three-phase PMSM drive system with copper loss minimization,” *IEEE Transactions on Power Electronics*, vol.38, no. 2, pp. 2351–2363, 2023.
- [10] H. H. Coban, M. Bajaj, V. Blazek, F. Jurado, and S. Kamel, “Forecasting energy consumption of electric vehicles,” in 2023 5th Global Power, Energy and Communication Conference (GPECOM), pp. 120–124, Nevsehir, Turkiye, 2023.
- [11] S. Liu and C. Liu, “Direct harmonic current control scheme for dual three-phase PMSM drive system,” *IEEE Transactions on Power Electronics*, vol.36, no. 10, pp. 11647–11657, 2021.

